

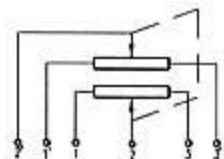

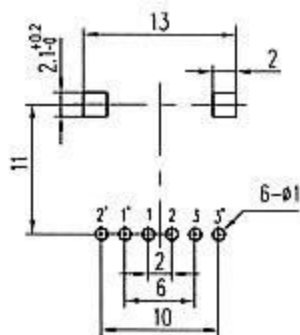

阻值允许误差 Tolerance of resistance	$\pm 20\%$
额定功率 power Rating	0.05W
额定电压 Rated voltage	50V AC/ DC 20V
转动噪声 Rotational noise	$\leq 47\text{mv}$
双联同步误差 Tracking error	0~40db $\pm 3\text{db}$

绝缘电阻 Insulation resistance	DC250V	100M Ω min
耐电压 Withstanding Voltage	AC300V	1 minute
总机械旋转角度 Total rotational Angle	300 $\pm 5^\circ$	
动作力 Operating force	20~200gf.cm	
轴回转止挡强度 Shaft stop strength	4Kgf.cm min	
机械耐久性 Mechanical endurance	10000周min turns	

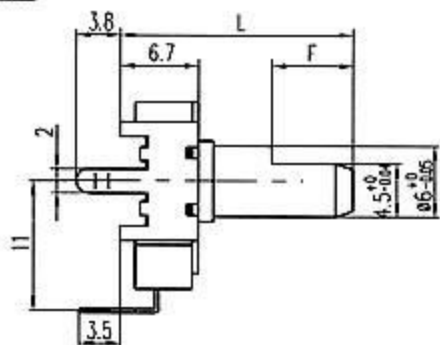
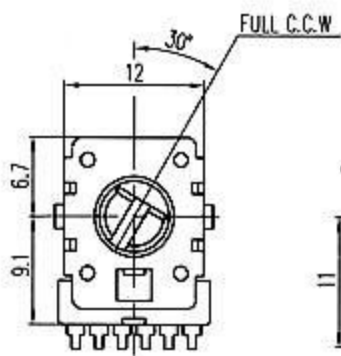

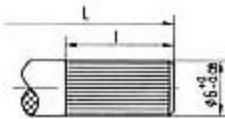
Standard Shaft Size:

 18T	型号	TYPE	L	12.5	15	17.5	20	22.5	25	30
		WH111-1 WH111-2 WH142-1 WH142-2	F		/	4.5	/		/	12
 F	WH111A-1 WH142A-1	WH111A-2 WH142A-2	l	7	7	12	12	12	12	12